

Characterization of metal–matrix composites fabricated by vacuum infiltration of a liquid metal under an inert gas pressure

JENG-MAW CHIOU, D. D. L. CHUNG

Composite Materials Research Laboratory, Furnas Hall, State University of New York, Buffalo, NY 14260, USA

Silicon carbide whisker-reinforced aluminium was fabricated by vacuum infiltration of liquid aluminium into a porous whisker preform under an argon gas pressure, using an infiltration temperature of 665 °C. The volume fraction of whiskers ranged from 11% to 37%. No whisker pull-out was observed on the fracture surface for an infiltration temperature of 665 °C, but some whisker pull-out was observed for an infiltration temperature of 720 °C. Both the tensile strength and ductility decreased with increasing infiltration temperature above 665 °C. Tensile test results from room temperature to 300 °C are reported. They showed that the quality of these composites was comparable to that of composites made by powder metallurgy or squeeze casting. The coefficient of thermal expansion at 100–150 °C was decreased by 45% by the addition of 37 vol % whiskers.

1. Introduction

Vacuum infiltration of a liquid metal under an inert gas pressure is a method of making metal–matrix composites [1–3]. In this method, the particulate or fibrous preform is placed in a mould and the matrix alloy is placed above the preform. The matrix alloy is heated to the liquidus temperature together with the mould and the preform under vacuum. Then an inert gas, such as argon, is compressed on the top surface of the matrix–alloy melt forcing the melt to infiltrate the preform. The pressure is 1000–2500 p.s.i. (6.9–17.2 MPa). As the melt is just at the liquidus temperature, the processing temperature is much lower than that in squeeze casting [4, 5]. Moreover, the pressure is an order of magnitude lower than that in squeeze casting. The low temperature lessens the interfacial reaction between the matrix and the filler, while the low pressure essentially eliminates preform compression. This paper provides the first study of the relationships between processing, structure and properties of composites made by using this method. For this purpose, this paper focuses on aluminium-reinforced by SiC whiskers.

2. Sample preparation

The whiskers are β -SiC (cubic) and are stoichiometric, with impurities less than 1000 p.p.m. The whisker diameter is 1–3 μm ; the whisker length is 30–200 μm .

The technique of liquid metal infiltration requires a porous preform which consists of the whiskers. Two methods were used to prepare preforms. The first method involves dispersing the whiskers in water in the presence of a silica colloid, which acts as a binder,

subjecting the dispersion to filtration under air pressure at about 10 p.s.i. and then drying in air at about 200 °C. The silica colloid content was 3–5 wt % of the preform. This method produces preforms with whisker volume fractions, V_f , ranging from 11% to 13%. The second method involves dry compression of the whiskers without any binder using a hydraulic press at up to 500 p.s.i. (3.45 MPa). The higher the pressure, the higher the V_f . This method was used to make preforms with V_f above 13% used in this study.

Fig. 1 shows scanning electron micrographs of (a) SiC whiskers from the raw material (i.e. prior to being made into a preform) and (b) SiC whiskers from a preform of $V_f = 12\%$. For the preform, the surface shown was parallel to the direction of the pressure during preform preparation. Fig. 1b shows that the whiskers were quite random in orientation in the preform. Moreover, comparison of Fig. 1a and b shows that the whisker distribution was more uniform in the preform than in the raw material.

Fig. 2 shows scanning electron micrographs of (a) the surface of the circular edge of a cylindrical preform (20 mm radius) of $V_f = 12\%$, and (b) the section of this preform at a distance of 1 mm from this surface. A much higher concentration of binder was present in Fig. 2a than in b. The photograph of Fig. 2b is representative of all parts of the preform other than the surface. Thus, the binder mainly resided at the surface of the preform, so that the interior region had a much lower binder concentration than the nominal concentration of 3–5 wt % of the preform. The origin of this effect is believed to be related to the transport of the binder toward the edge as the water evaporated from the binder during drying.

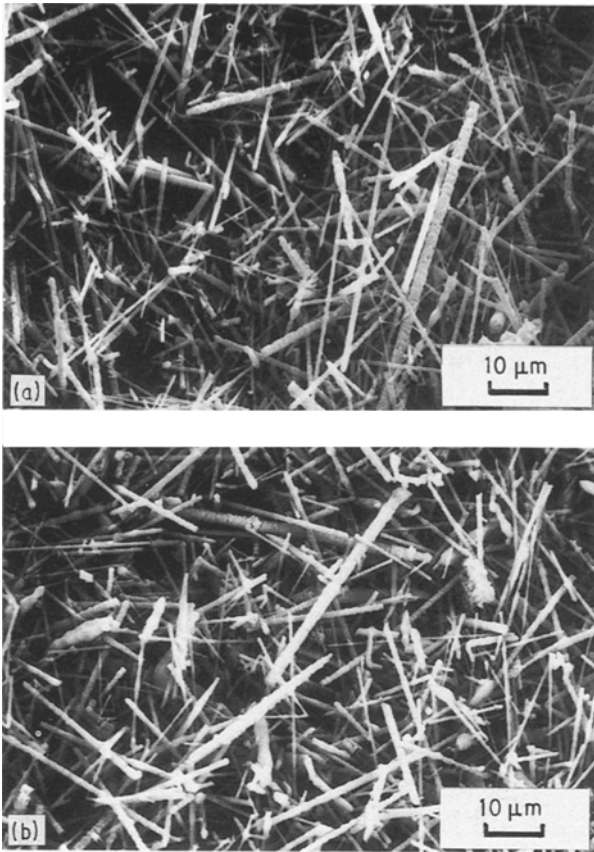

Figure 1 Scanning electron micrographs of (a) SiC whiskers prior to being made into a preform, (b) SiC whiskers in a preform of $V_f = 12\%$.

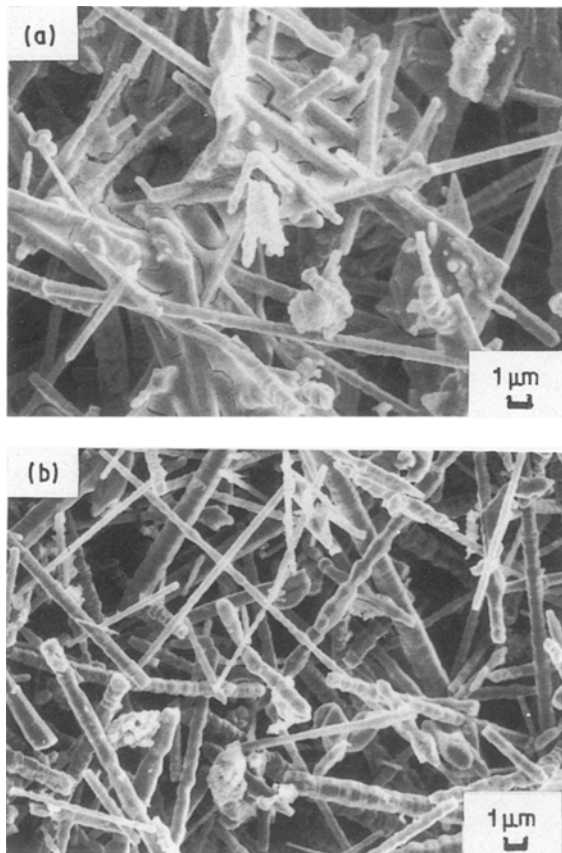

Figure 2 Scanning electron micrographs of (a) the surface of a SiC whisker preform of $V_f = 12\%$, and (b) a section at a distance of 1 mm from this surface.

In order to make a metal–matrix composite, a preform was placed at the bottom of a steel mould (Fig. 3). Above the preform was placed an aluminium ingot. The mould chamber was evacuated using a mechanical vacuum pump (A_0 – A_1 in Fig. 4). Then the chamber was heated to a temperature 50–100 °C above the liquidus temperature of the alloy (A_1 – A_2 in Fig. 4). The temperature was maintained for a period of time to ensure that the alloy melted completely and that the temperature of any part of the chamber was approximately equal (A_2 – A_3 in Fig. 4). Then the temperature was allowed to drop at a rate of 0.5 to 3.0 °C min^{-1} to the liquidus temperature or near to the liquidus temperature (A_3 – A_4 in Fig. 4). With the temperature maintained at this value, called T_p , argon gas pressure at 1000–2500 p.s.i. (6.9–17.2 MPa) was applied to the surface of the melt to force the melt to penetrate the porous preform completely (A_4 – A_5 in Fig. 4). Once the predetermined pressure was reached, the chamber was cooled with the help of a cooling water jacket outside the chamber (A_5 – A_6 in Fig. 4). When the temperature was 300 °C, the pressure started to be released (A_6 – A_7 in Fig. 4).

The silica binder remained amorphous after going through the process of Fig. 4, carried out up to 760 °C for 20 min, as shown by X-ray diffraction.

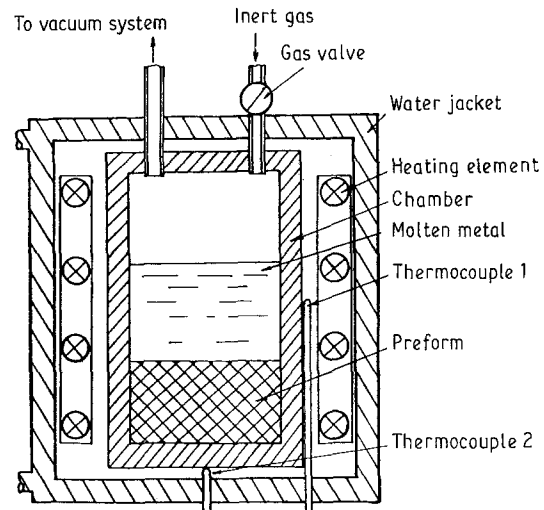

Figure 3 Schematic illustration of the steel mould for making metal–matrix composites by vacuum infiltration of a liquid metal under an inert gas pressure.

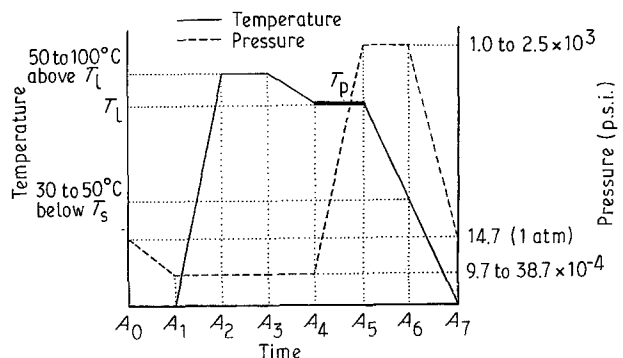

Figure 4 Variation of (—) temperature and (---) pressure in the process of making a metal–matrix composite.

The infiltration temperature, T_p , is the most important processing parameter. Therefore, in this work, T_p was varied and its effect on the structure and properties was investigated. Unless indicated otherwise, $T_p = 665^\circ\text{C}$ in this work.

The metal used was aluminium (170.1), the tensile strength of which was 65 MPa. Its composition was Al(99.77%), Fe(0.16%) and Si(0.07%). The melting temperature is 660°C .

3. Results and discussion

3.1. Structure

Fig. 5 shows scanning electron micrographs of polished and etched surfaces of Al containing 12 vol % SiC whiskers. The surfaces were parallel to the direc-

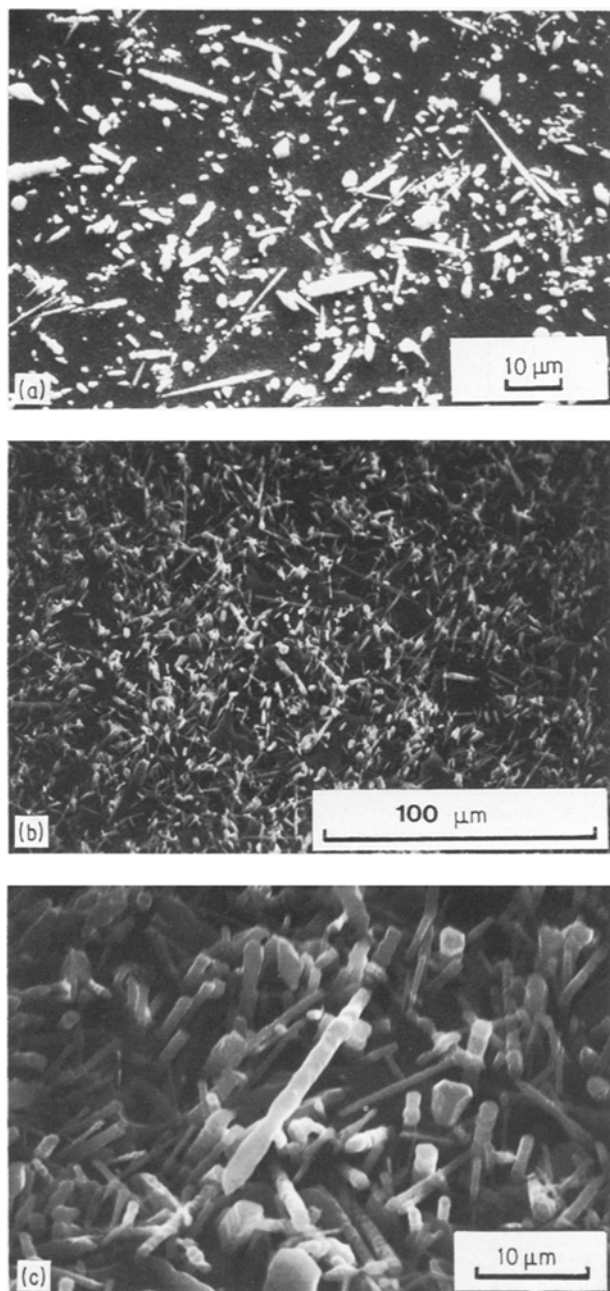

Figure 5 Scanning electron micrographs of polished and etched surfaces of Al containing 12 vol % SiC whiskers. (a) A lightly etched specimen; (b) and (c) A heavily etched specimen at two different magnifications.

tion of the pressure during preform preparation. Fig. 5a shows a polished and etched (using 0.5 vol % HF and 99.5 vol % H_2O) surface, whereas Fig. 5b and c show a polished and severely etched (using 45 vol % HCl, 15 vol % HNO_3 and 15 vol % HF (at 48%) and 25 vol % H_2O) surface at two different magnifications. As the etchant preferentially attacked the metal, the etched surface in Fig. 5b and c is protruded by SiC whiskers. Fig. 5a–c are all consistent with the fact that the whiskers are quite random in orientation.

3.2. Mechanical testing method

Tensile testing was performed using a hydraulic mechanical testing system (MTS). Each sample was in the shape of a dogbone, as shown in Fig. 6. The Young's modulus was measured using a strain gauge at low loads. The yield strength was the 0.2% offset yield strength. The ductility was determined by drawing two parallel lines marking the gauge length on the sample and measuring the distance between the lines before and after tensile testing using calipers.

High-temperature tensile testing was performed using the same method, except that a resistance furnace was placed around the sample. The temperature accuracy was $\pm 10^\circ\text{C}$. Each sample was preheated at the test temperature for 100 h prior to testing, in order to allow time for the interfacial reaction between the whiskers and the matrix to take place [6].

3.3. Effect of the infiltration temperature

Composites containing 12 vol % SiC whiskers were fabricated with different values of T_p , the infiltration temperature. Table I shows the mechanical properties at room temperature; Table II shows the mechanical

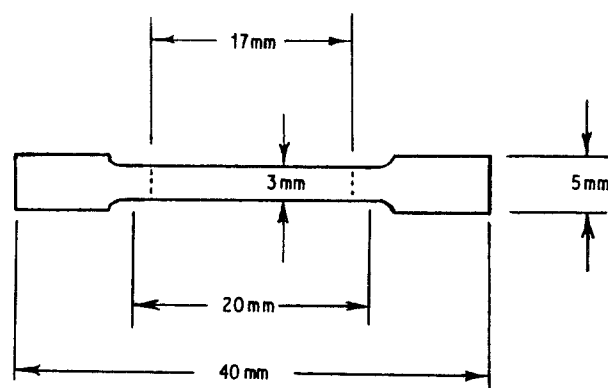

Figure 6 Specimen geometry for tensile testing. (---) Gauge length markings on the specimen.

TABLE I Mechanical properties at room temperature of composites (containing 12 vol % SiC whiskers) prepared at different infiltration temperature T_p

T_p ($^\circ\text{C}$)	Tensile strength (MPa)	Yield strength (MPa)	Young's modulus (GPa)	Ductility (%)
665	181	100	89	6.9
690	140	81	80	4.3
720	130	—	—	—

TABLE II Mechanical properties at 300 °C of composites (containing 12 vol% SiC whiskers) prepared at different infiltration temperatures, T_p

T_p (°C)	Tensile strength (MPa)	Ductility (%)
665	137	12.4
690	118	9.1
720	86	1.7

properties at 300 °C. For both room temperature and 300 °C, the lower the value of T_p (but still above the melting temperature 660 °C), the higher were the tensile strength and the ductility. This is attributed to the increasing severity of the interfacial reaction [6] with increasing T_p . Thus, $T_p = 665$ °C was chosen for investigating the dependence of the mechanical properties on the volume fraction of SiC whiskers.

Fig. 7 shows the fracture surfaces for T_p of 720 and 665 °C, as revealed by SEM. Some whisker pull-out was observed for $T_p = 720$ °C, but no whisker pull-out was observed for $T_p = 665$ °C. This indicates that the bonding between the whiskers and the matrix was better at $T_p = 665$ °C. This is attributed to the more severe interfacial reaction for $T_p = 720$ °C. The reaction between SiC and Al results in aluminium carbide [6], which is deleterious to the bonding strength.

3.4. Mechanical properties at room temperature

Fig. 8 shows the tensile stress–strain curves at room temperature for composites containing 0–37 vol% SiC whiskers. The greater was the volume fraction of

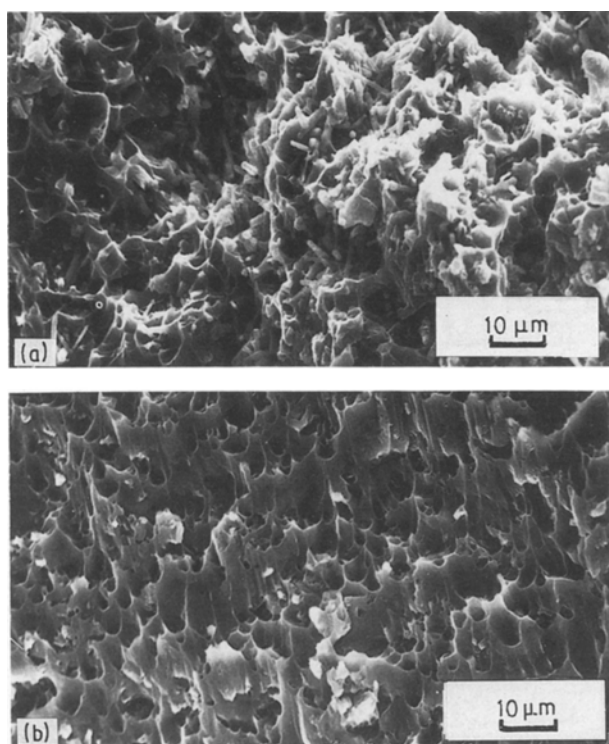

Figure 7 Scanning electron micrographs of the fracture surfaces of composites containing 12 vol% SiC whiskers, fabricated with the infiltration temperature T_p of (a) 720 and (b) 665 °C.

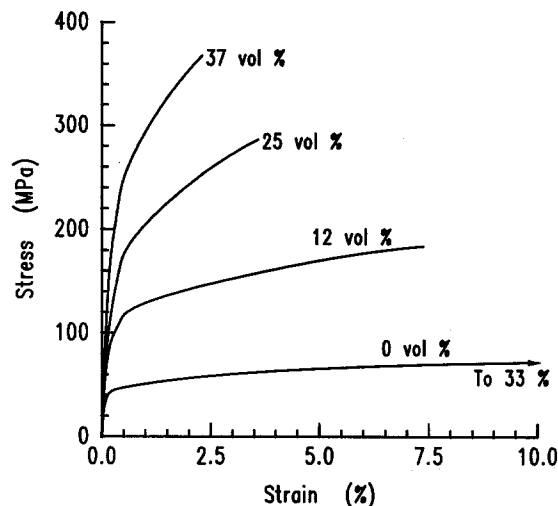

Figure 8 Tensile stress–strain curves at room temperature for composites containing 0–37 vol% SiC whiskers.

whiskers, the higher were the tensile strength and the tensile modulus and the lower was the ductility.

Figs 9 and 10 show the variation of the tensile strength and 0.2% yield strength with the volume

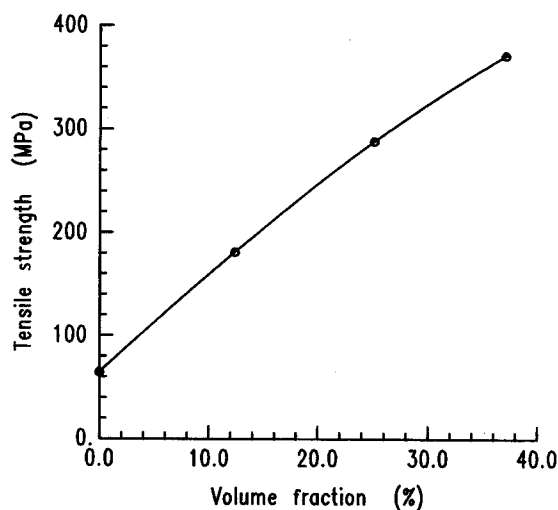

Figure 9 Variation of the tensile strength with the volume fraction of SiC whiskers.

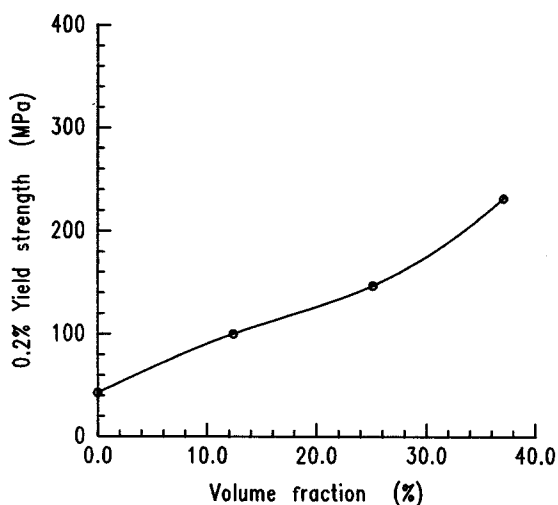

Figure 10 Variation of the 0.2% yield strength with the volume fraction of SiC whiskers.

fraction of whiskers, respectively. Figs 11 and 12 show the variation of the modulus and ductility with the volume fraction, respectively. In particular, for a volume fraction of 37%, the tensile strength was in-

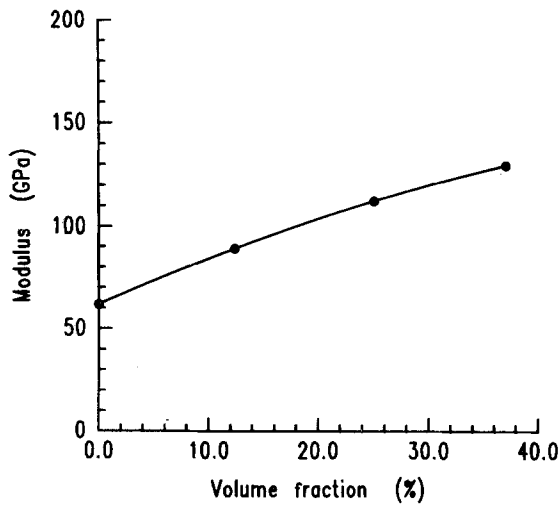

Figure 11 Variation of the tensile modulus with the volume fraction of SiC whiskers.

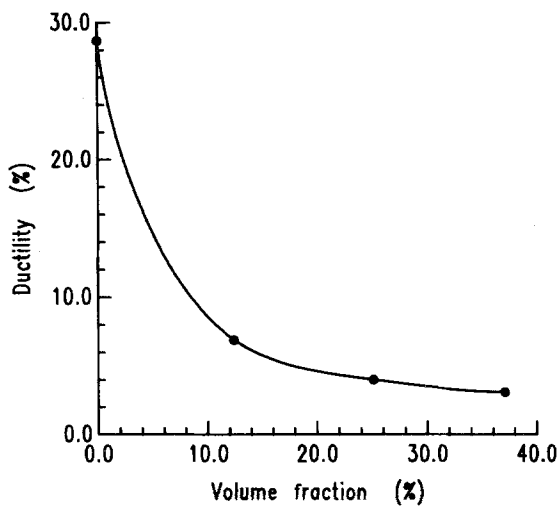

Figure 12 Variation of the tensile ductility with the volume fraction of SiC whiskers.

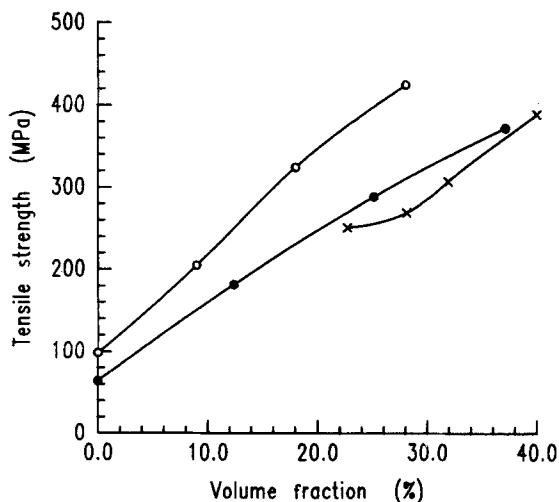

Figure 13 Comparison of the tensile strength of composites of (●) this work, (○) Nieh and Chellman [7] and (×) Kobayashi *et al.* [4].

creased by 474% and the modulus was increased by 108%, compared to the corresponding values for 0% whiskers.

Fig. 13 shows the comparison of the tensile strengths of composites of this work with those of composites prepared by powder metallurgy [7] and squeeze casting (at 13 000 p.s.i. = 92 MPa) [4], which are the two most established methods for making such composites. The similarity between the three sets of data shows that the composites prepared by vacuum infiltration of a liquid metal under an inert gas pressure (this work) is comparable in quality to those prepared by powder metallurgy and squeeze casting, which are more expensive methods. The composites of this work used 99.77% Al as the matrix whereas those of [7] used 99.00% Al as the matrix, and those of [4] used 99.9% Al as the matrix.

Fig. 14 shows the fracture surfaces of composites (this work) containing 12, 25 and 37 vol% SiC whiskers. No whisker pull-out was observed in any of those composites. Dimples were observed most clearly

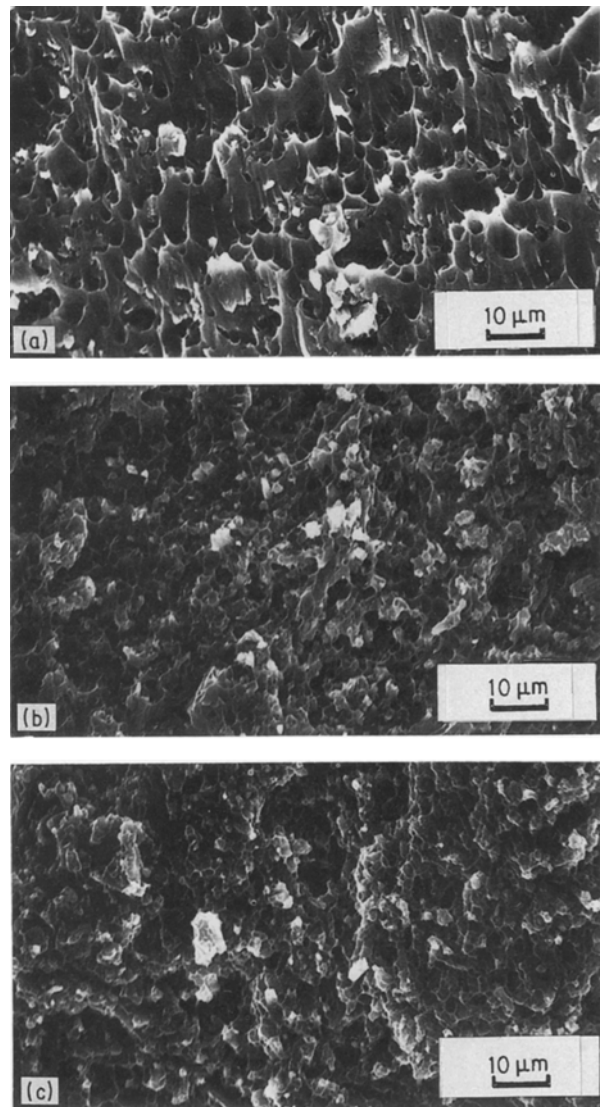

Figure 14 Scanning electron micrographs of the room-temperature fracture surfaces of composites containing (a) 12, (b) 25 and (c) 37 vol% SiC whiskers.

for a volume fraction of 12%, indicating localized ductility for this composite.

3.5. Mechanical properties at elevated temperatures

Fig. 15 shows the tensile strength as a function of whisker volume fraction at 20 and 300 °C, while Fig. 16 shows the ductility as a function of whisker volume fraction at these two temperatures. The increase in temperature decreases the strength but increases the ductility. This is attributed to the increasing plasticity of the matrix with increasing temperature and the more significant role of the matrix at lower whisker volume fractions.

Fig. 17 shows the variation of the tensile strength with temperature for 11.4 vol % whiskers.

Fig. 18 shows the fracture surfaces of composites (0, 12, 25 and 37 vol % SiC whiskers) after tensile testing at 300 °C. All four photographs in Fig. 18 are at the same magnification. Dimples were clearly observed for all four compositions, although the dimple size decreased markedly with increasing whisker volume

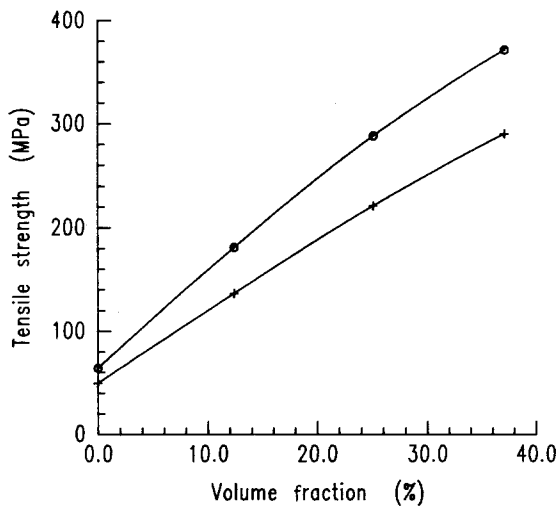

Figure 15 Tensile strength versus SiC whisker volume fraction at (○) 20 and (×) 300 °C.

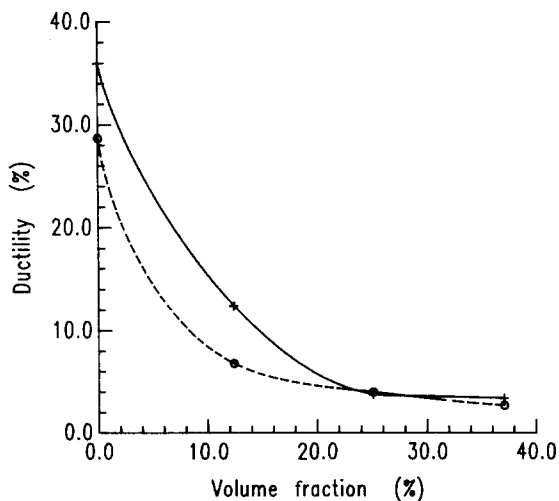

Figure 16 Ductility versus SiC whisker volume fraction at (○) 20 and (×) 300 °C.

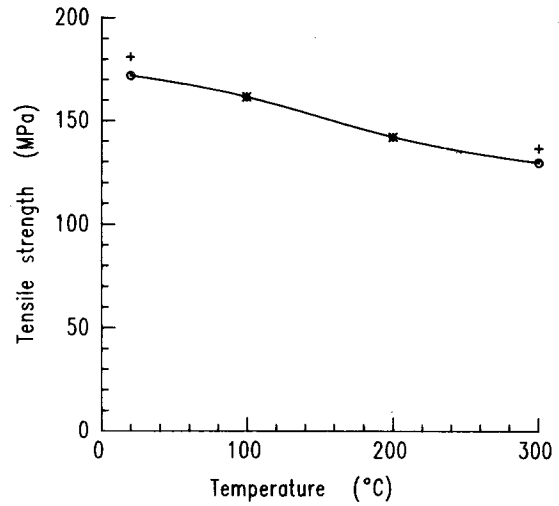

Figure 17 Variation of the tensile strength with temperature for composites containing (*) 11.4 vol % SiC whiskers and (+) 12.4 vol % SiC whiskers. (○) Values obtained by extrapolating the strength from a whisker volume fraction of 12.4 to 11.4%, using Fig. 15.

fraction. Whisker pull-out was observed in all three composites.

3.6. Thermal expansion

The coefficient of thermal expansion (CTE) was measured by using a Mettler TMA40 thermal mechanical analyser operated at a heating rate of 10 °C min⁻¹. The temperature was scanned from 30–510 °C. Prior to the measurement, the specimens were annealed in vacuum at 500 °C for 3 h and then furnace cooled. Table III shows the CTE values at 100 and 150 °C for composites containing from 0 to 37 vol % SiC whiskers. The CTE value decreased markedly with increasing whisker content.

Low thermal expansion aluminium–matrix composites are technologically used for electronic packaging, especially the packaging of microwave devices. One such composite in the market is aluminium containing 40 wt % Si particles. Its CTE value is $13.5 \times 10^{-6} \text{ K}^{-1}$ at temperatures from room temperature to about 100 °C [8]. This value is about equal to the value of the composite containing 25 vol % SiC whiskers at 100 °C in this work. On the other hand, the Al/Si composite is brittle, with a ductility of only 1.2% [8], compared to a ductility of 4.0% for our Al/SiC composite containing 25 vol % SiC whiskers. Furthermore, the tensile strength of the Al/Si composite is 255 MPa [8], compared to a tensile strength of 288 MPa for our Al/SiC composite containing 25 vol % SiC whiskers: the tensile modulus of the Al/Si composite is 101 GPa [8], compared to a tensile modulus of 112 GPa for our Al/SiC composite containing 25 vol % SiC whiskers.

4. Conclusion

The method of vacuum infiltration of liquid aluminium under an argon gas pressure produced SiC whisker-reinforced aluminium which was comparable in quality to those produced by powder metallurgy or

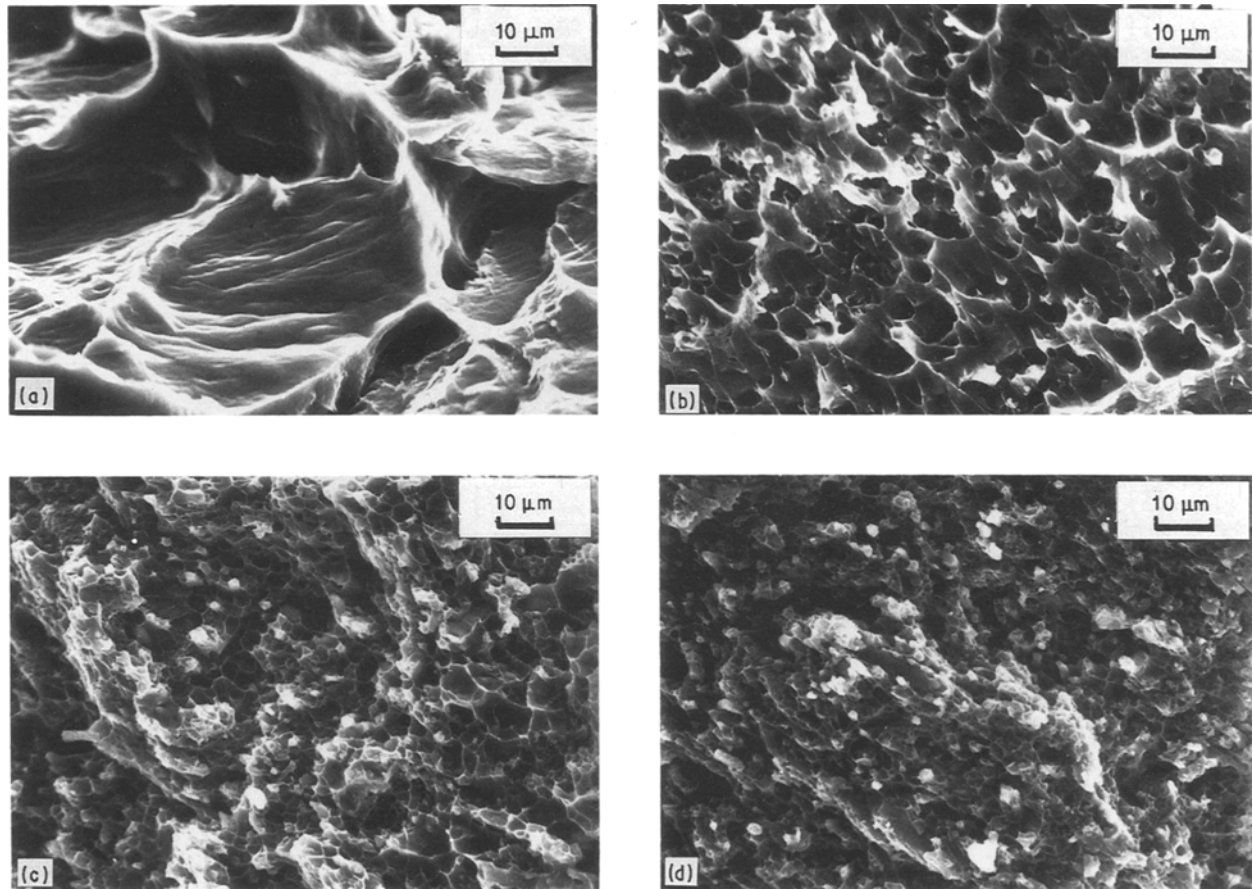

Figure 18 Scanning electron micrographs of the 300 °C fracture surfaces of composites containing (a) 0, (b) 12, (c) 25 and (d) 37 vol % SiC whiskers.

TABLE III Coefficient of thermal expansion (CTE)

SiC (vol %)	CTE (10^{-6} K^{-1})	
	100 °C ^a	150 °C ^a
0	21.3 (0.31)	23.6 (0.33)
12	18.8 (0.17)	20.8 (0.46)
25	14.4 (0.29)	16.2 (0.05)
37	11.8 (0.34)	13.1 (0.25)

^a Standard deviation is shown in parentheses.

squeeze casting, as shown by tensile testing. The infiltration temperature used was 665 °C – just a little above the melting temperature (660 °C) of aluminium. Whisker pull-out was not observed on the room-temperature fracture surfaces for composites made at this infiltration temperature, though whisker pull-out was observed on the 300 °C fracture surfaces. The coefficient of thermal expansion was decreased by the whiskers to a level which makes the composites containing 25 or 37 vol % SiC whiskers particularly suitable for applications in electronic packaging, in addition to structural applications.

Acknowledgements

This research was supported by Nebo Corporation. Technical discussions with Jingyu Yang, Southeast University, People's Republic of China, are greatly appreciated.

References

1. JINGYU YANG and D. D. L. CHUNG, *J. Mater. Sci.* **24** (1989) 3605.
2. A. MORTENSEN, J. A. CORNIE and M. C. FLEMINGS, *Metall. Trans.* **19A** (1988) 709.
3. S. NOURBAKHSH, F. L. LIANG and H. MORGOLIN, *J. Phys. E: Sci. Instrum.* **21** (1988) 898.
4. TOSHIRO KOBAYASHI, MASAKI YOSINO, HIROYOSHI IWANARI, MITSUO NIINOMI and KUNJI YAMAMOTO, in "Proceedings of the International Symposium on Advances in Cast Reinforced Metal Composites", 1988, edited by S. G. Fishman and A. K. Dhingra (ASM International, 1988) pp. 205–10.
5. R. J. SAMPLE, R. B. BHAGAT and M. F. AMATEAU, *ibid.*, pp. 179–83.
6. K. KANNIKESWARAN and R. Y. LIN, *J. Metals* September (1987) 17.
7. T. G. NIEH and D. J. CHELLMAN, *Scripta Metall.* **18** (1984) 925.
8. Sumitomo Electric Industries Ltd, CSMH A-40 technical information, EP-46 (1988, 11).

Received 26 September 1989
and accepted 9 April 1990